



SEC *Heat Exchangers*

INSTALLATION MANUAL FOR THE SEC SERIES Heat Exchangers

Index

- I. Application
- II. Construction Features
- III. Operating Principle
- IV. Material
- V. Operating Parameters and Selection of Heat Exchangers
- VI. Operating Precautions
- VII. Installation
- VIII. Dimensions
- IX. Name Plate
- X. Storage/Transportation
- XI. Start up
- XII. Insulation
- XIII. Cleaning
- XIV. Certification
- XV. Warranty Terms
- XVI. Warranty Claims Form
- XVII. Sales and Service

I. APPLICATION

Heat exchangers are designed to transfer heat between liquids and vapours at various temperatures, fluid flows, and pressures.

They are often utilized in the following applications:

- District heating installations
- Hot water systems
- Refrigeration (condensers, evaporators)
- Various process systems (heat recovery, aftercooling, etc.)

The construction and robust materials of SEC Heat Exchangers enables them to be used with various fluids and chemicals.

II. CONSTRUCTION FEATURES

The heat exchangers are designed and fabricated as a single unit with non-removable parts.

The cylindrical shell encloses a tube bundle which consists of circular layers of helically, corrugated tubes. Each layer flows in the opposite direction to the layers surrounding it in a criss-cross manner. The tube bundle has perforated bottoms which are welded near the connections. Both ends of the cylindrical shell are enclosed within hemispherical heads.

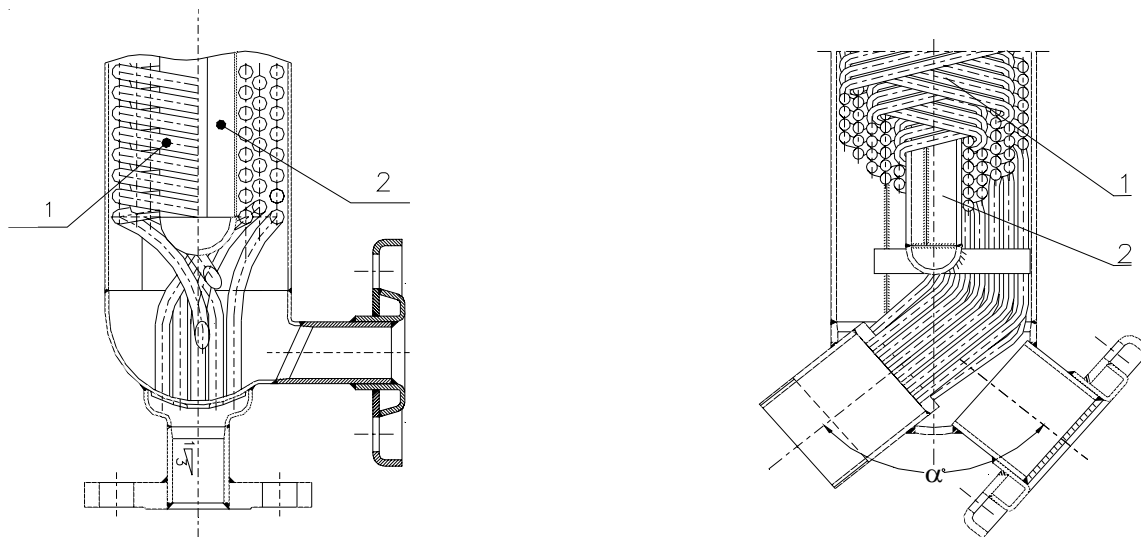

Figure 1 : Cross Section of H (left) and X (right) type Heat Exchangers. 1-Tube Bundle, 2-Core.

There are two variations to each model line of SEC Series heat exchangers, X and XK. SEC X heat exchangers consist of tube bundles made of smooth tubes, whereas SEC XK heat exchangers consist of tube bundles with corrugated tubes. S-type heat exchangers are shortened versions of the SEC Series and are usually installed in applications where there are height limitations. H-type heat exchangers have straight, 90° angle connections.

Each heat exchanger has a total of four (4) symmetrically located connections, two on each hemispherical head. One pair of opposing connections is connected to the tube side while the other pair is connected to the shell side.

III. OPERATING PRINCIPLE

A heat exchanger is a device in which heat is transferred from one flowing fluid to another. Shell and Tube heat exchangers are the most common type of heat exchangers for liquid/liquid service although many applications also involve steam and certain gases. SEC heat exchangers are counterflow units, which from a thermodynamic point of view, extract more heat from a given fluid stream than the other common types of heat exchangers.

Normally, the heating medium flows through the tubes, although for specific properties or conditions (e.g. high viscosity, high pressure drops), the heating medium can flow through the shell side. Thermal energy is transferred through the tube walls. The total heat load is dependent on the flow parameters of the fluid.

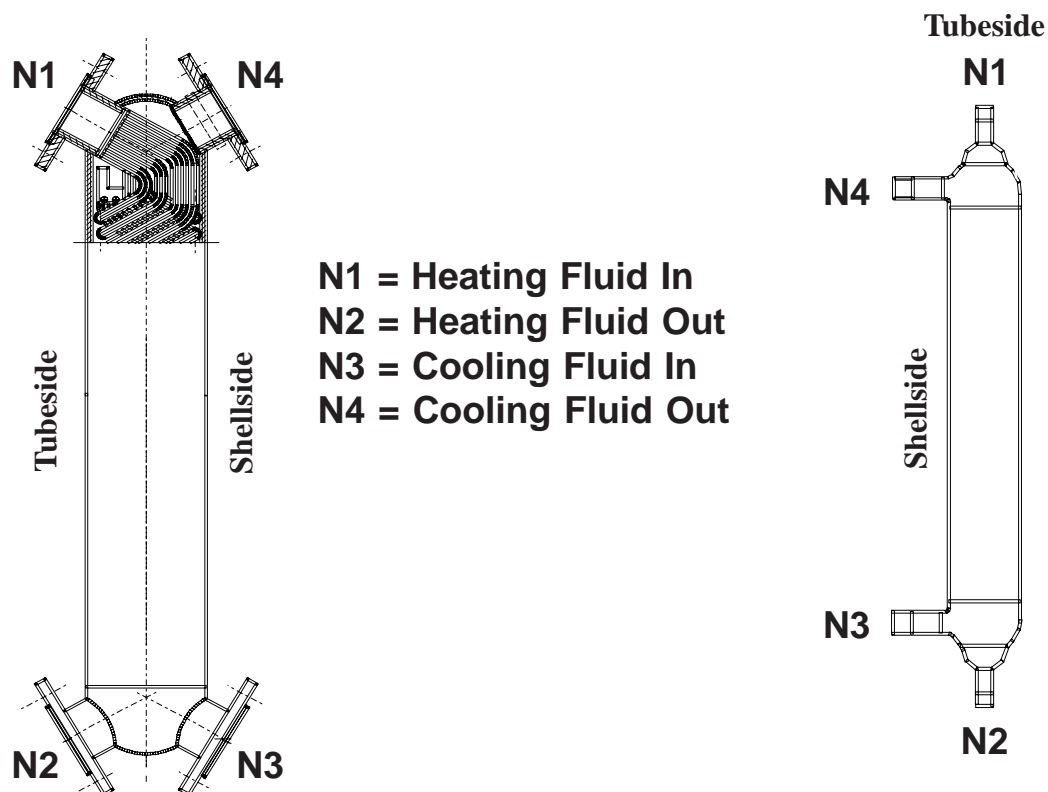
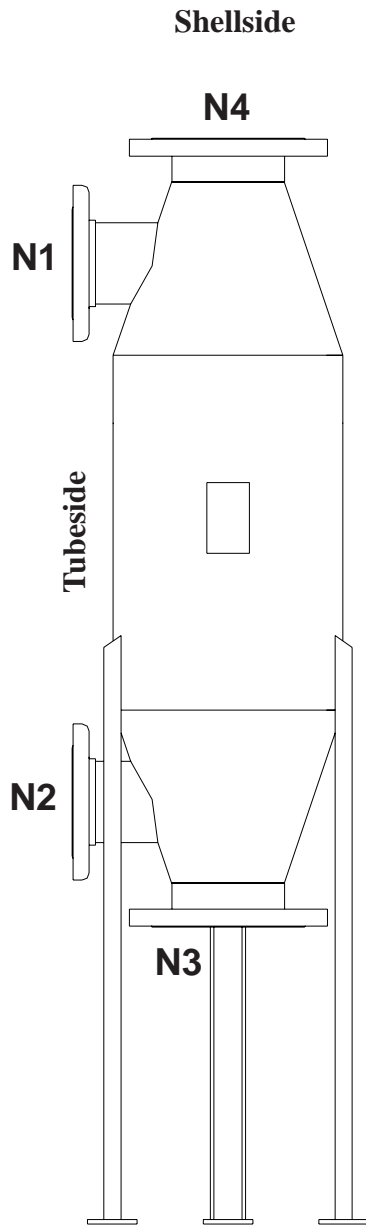

Figure 2 : Flow Distribution in Heat Exchangers



N1 = Heating Fluid In
N2 = Heating Fluid Out
N3 = Cooling Fluid In
N4 = Cooling Fluid Out

IV. MATERIALS

SEC heat exchangers are typically manufactured according to the following table, although different materials may be used to suit specific customer requirements.

Standard Materials

Shell	316L Stainless Steel
Tubes	316L Stainless Steel
Nozzle	316L Stainless Steel
Connection flanges	316L Stainless Steel

V. OPERATING PARAMETERS AND SELECTION OF HEAT EXCHANGERS

Standard maximum working parameters of the heat exchangers are as follows:

(Units designed with different parameters are available)

Design Pressure

Shell	250 psig	(1.7 MPa)
Tube	250 psig	(1.7 MPa)

Design Temperature

Shell	406 °F (208 °C)
Tube	406 °F (208 °C)

In order to select the proper heat exchangers, a customer should specify the following information:

- type of medium
- required heat load
- required inlet/outlet temperature of heating medium
- required inlet/outlet temperature of heated medium

Selection is made through a computer software program developed by SEC Heat Exchangers.

VI. OPERATING PRECAUTIONS

In order to achieve maximum performance from the heat exchanger, the following must be strictly followed:

- Heat exchangers should be used according to the specification given to SEC.
- Pressures and temperatures should not exceed limits set forth in *Section V: Operating Parameters and Selection of Heat Exchangers*.
- Initial start up should be done according to *Section XI: Start Up*.
- Heat exchangers should be free of any debris existing in the fluid.
- In domestic hot water applications, hot water in excess of 150 °F increases heat exchanger fouling.
- Prevent evaporation of fluid on the shell side. Steam or vapour should only flow through the tubes.

- Clean heat exchangers according to *Section XIII: Cleaning*.
- The system should be designed to prevent the heat exchanger from encountering pressure shocks.
- Prevent rapid temperature increases in the heat exchangers. This would include installation of expansion tanks and safety valves into the system.
- Prevent any of the fluids from dropping below their freezing point.

VII. INSTALLATION

Heat exchangers should be mounted vertically by means of stainless steel brackets or stands. They can be mounted to a wall or can stand individually away from the wall by use of the stands. Install the heat exchanger in a manner where it will not be exposed to mechanical stresses or moments. (example: in cases of pipe expansions, use expansion compensators to relieve the stress from the connections of the heat exchanger). Contact of carbon steel with the heat exchanger is not allowed.

The following is an example of mounting technique:



Figure 3 : Mounting examples of SEC Series heat exchangers with elbows attached

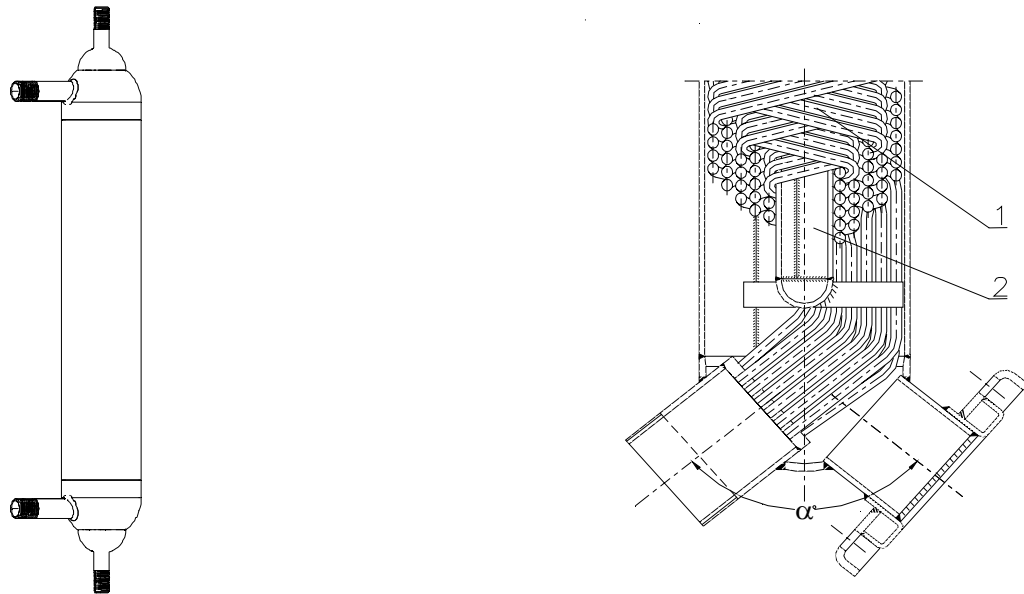

Figure 4 : Installation of H-type heat exchanger & Mounting example of S-type heat exchanger

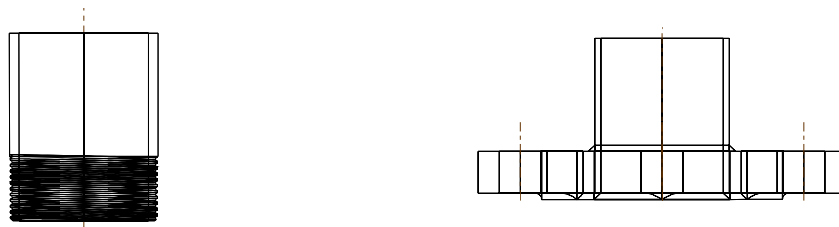

Figure 5 : Threaded & Flanged (compatible with CL300) connections



Figure 6 : Heat Exchanger mounting bracket



Figure 7 : Complete installation diagram

Installation Procedure

- 1.** Mount heat exchanger wall brackets to the wall.
- 2.** Set the heat exchanger unit against the bracket.
- 3.** Fasten the metal straps around the unit, and screw into place.

Note : This installation configuration only applies to the SEC S-line of heat exchangers

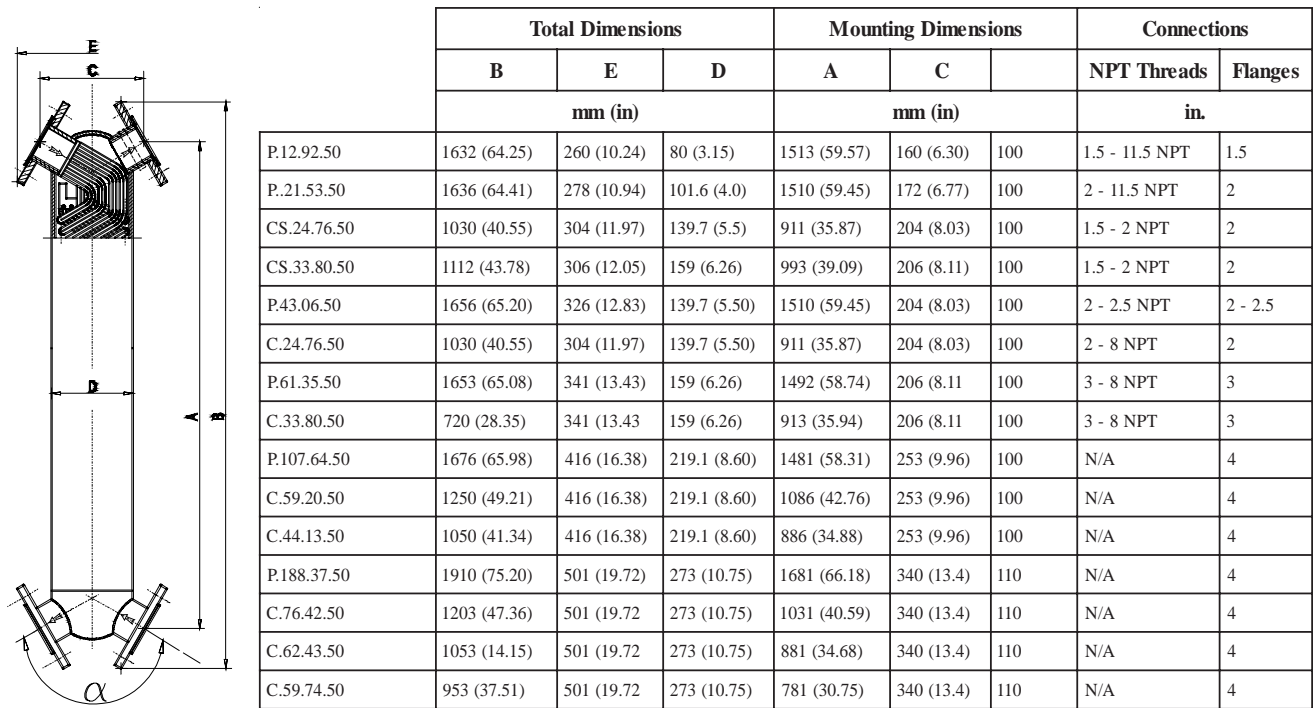

Figure 8 : Dimensions of SEC Series S type heat exchangers

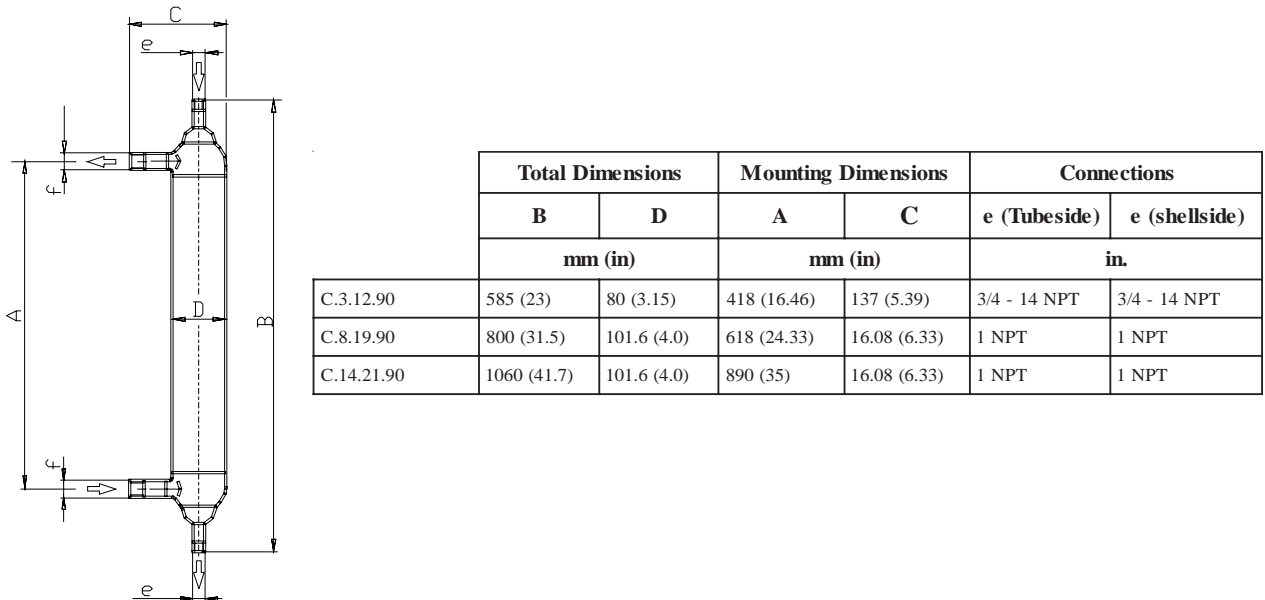

Figure 9 : Dimensions of H type heat exchangers

IX. NAME PLATE

The name plate is placed on the shell and includes the following data:

- type of heat exchanger
- serial number
- production year
- maximum working pressure and temperature
- heat transfer area
- ASME and CSA stamps of approval
- CRN registration number
- manufacturer logo
- manufacturer code

X. STORAGE & TRANSPORTATION

Heat exchangers should be stored in a clean place away from corrosive environments or weather elements (e.g. rain). During transportation, ensure that they are not exposed to mechanical damages.

XI. STARTUP

To prepare the heat exchanger for operation, it should initially be:

- mounted properly
- filled with working fluids
- deaerated
- all connections checked for leaks

During startup, first open the valves, then start the pump of the heated medium followed by opening the cycle of the heating medium. The valves should be opened gradually in order to achieve a steady increase in flow and pressure. The pressure increase/decrease should not exceed 0.5 MPa/min (72 psi/min.).

XII. INSULATION

After installation of the heat exchanger, the units should be insulated.



Figure 10 : Complete installation diagram



Figure 11 : Insulation tied with straps



Figure 12 : Straps with fastener

SEC offers insulation for its SEC Series heat exchanger products. Insulation is mainly used to reduce heat loss, and also offers the operator some degree of personal protection from the hot surface of the unit. The insulation is designed for temperatures up to 130°C, and weighs approx 1.6 kg to 2.7kg, depending on the insulation size. For pricing and availability on insulation please contact your dealer or SEC Heat Exchangers at 1.902.659.2424.

XIII. CLEANING

The heat exchangers are cleansed by flushing the units with fluids which do not react with stainless steel.

Dirt deposited in the heat exchanger will result in an increase in pressure drop, lower temperature difference in the heated medium or a higher exit temperature on the heating medium side. Flushing can be done without removal of the heat exchanger from the system, although extra connections and bypasses would be required.

The following fluids are prohibited for use as a flushing agent:

- hydrochloric acid up to 0.1 % concentration
- solutions which contain MCl
- Chlorides ($MgCl_2$, NaCl between 0.01 - 1%, CuCl up to 1%, $CaCl_2$ from 5% to saturation, KCl, $MgCl_2$)
- any fluid which would deposit alkaline residue or phosphorous

The cleaning solutions are easily assessable at businesses carrying chemical cleaning agents for heat exchangers or tubing and piping applications. As a guideline to purchasing the cleaning solutions, check for the following product data:

- compatibility with stainless steel
- accepted for use in food processing industries (if applicable)
- removes scale, slag, tarnishes, and hard water deposits
- easily rinsed out of the system
- no objectionable or corrosive fumes

XIV. CERTIFICATION

SEC heat exchangers are designed and fabricated in accordance with ASME Code Sec. VIII, Div.1 for symbols "U" and "UM". The heat exchangers are CSA approved and have obtained the CRN in the Canadian provinces. SEC is ISO-9002 certified.

Copies of the above certificates are available upon request.

XV. WARRANTY TERMS

SEC HEAT EXCHANGERS LIMITED WARRANTY INFORMATION

SEC Heat Exchangers warranty obligations are limited to the terms set forth below:

SEC HEAT EXCHANGERS (“SEC”) warrants to the original purchaser that this product will be free of manufacturing defects in material and workmanship for a period of one (1) year from the original purchase date, or eighteen (18) months from SEC’s original invoice, whichever expires first. The original purchase date as used herein shall mean the date stated in the vendor’s original invoice.

SEC HEAT EXCHANGERS will, at its option, repair or replace this product without charge if it is found to be defective during the limited warranty period specified above. If SEC chooses, at its discretion, to replace any product for which there is a valid warranty claim, SEC shall replace the product with the same model or, if such model is not available, with a model which is, in SEC’s reasonable judgment, the nearest compatible model available at the time of replacement. Note that each purchaser is limited to one (1) product replacement during the warranty period of the original claim.

NOT UNDER COVERAGE BY THIS WARRANTY

This limited warranty covers defects encountered in normal use of the product while operating according to the specifications set forth by SEC. The warranty is void and shall not apply to the following, including, but not limited to:

1. The failure or malfunction results from improper or negligent operation, abuse, misuse or maintenance or unauthorized alteration.
2. Malfunctions resulting from, or repairs necessitated by, uses of the product for purposes other than that for which it was designed, or resulting from flood, fire, wind, lightning, freezing, or any other natural disaster, an act of God, an act of destruction, theft, or accident.
3. Damages to the product that occur during shipment.
4. Damages caused by improper or faulty installation.
5. Products exposed to corrosive elements harmful to the structural integrity and durability of the product.
6. Products installed outside of Canada and the United States.

SEC shall not be liable for any direct, special, incidental, or consequential damages caused by the use, misuse, or inability to use this product. SEC is under no legal obligations to rectify, including but not limited to, lost profits, downtime, goodwill, damages to or replacement of equipment and property. Purchaser assumes all risk and liability for loss, damage or injury to purchaser and purchaser’s property and to others and their property arising out of the use, misuse or inability to use this product. This limited warranty shall not extend to anyone other than the original purchaser of the product.

MAKING A WARRANTY CLAIM

To file a claim under this warranty, the purchaser must do the following during the warranty period:

Before returning the product to SEC for warranty service, the purchaser must complete the Warranty Claims Form (attached) and fax it to SEC at **(902) 659-2800**. Upon preliminary assessment of the claim, SEC will send the purchaser a Request for Inspection Form, along with an Inspection Tag and a Return Merchandise Authorization (RMA) number. The Inspection Tag and RMA number must be clearly displayed and attached to the product on its return to SEC before it can be processed. Proper packing of the product in the original container, or equivalent, is the responsibility of the purchaser. This warranty does not cover expenses or labour for disassembly, removal, shipment, reassembly or reinstallation; the purchaser will be responsible for such costs.

SEC RESERVES THE RIGHT TO CHANGE SPECIFICATIONS OR DISCONTINUE MODELS WITHOUT NOTICE.

XVI. WARRANTY CLAIMS FORM

SEC WARRANTY CLAIMS FORM

SEC warrants this product against defects in materials and workmanship for a period of one (1) year from the original purchase date, or eighteen (18) months from SEC's original invoice, whichever expires first. The original purchase date as used herein shall mean the date stated in the vendor's original invoice. Should the product fail to perform according to the specifications set forth by SEC during the warranty period, SEC will repair or replace, free of charge, the products that it finds defective.

If you wish to make a warranty claim, please complete this form. Incomplete forms will not be processed. To make multiple claims, please fill out one form for each individual unit.

Name: _____
 Company: _____
 Address: _____
 Telephone: _____ Fax: _____

Product Information:

Model Name: _____
 Serial Number: _____
 Purchased From: _____
 Vendor Invoice # : _____
 Vendor Invoice Date: _____
 SEC's Quotation #: (if applicable) _____

Comments:

(indicate source/symptoms of defect)

Product Operating Conditions:

	Tube Side	Shell Side
Temperature In <input type="checkbox"/> °C <input type="checkbox"/> °F		
Temperature Out <input type="checkbox"/> °C <input type="checkbox"/> °F		
Flow <input type="checkbox"/> kg/s <input type="checkbox"/> USGPM		
Operating Fluids		

For pool use, please complete the following table:

<i>Chemical</i>	<i>Levels</i>
Free Chlorine	
pH	
Calcium Hardness	
Alkalinity	
Total dissolved solids	
Bromine	
Copper	
Chloride	
Other (Specify)	

Thank you for your assistance. Please fax this form back to SEC Heat Exchangers. You will be contacted once the information has been reviewed.

SEC FAX NUMBER 902.659.2800

For Office Use

Date Claim Received: _____
 RMA#: _____

XVII. SALES AND SERVICE

SEC HEAT EXCHANGERS serves its customers through a network of distributors. For application assistance, performance specifications, pricing, or name of the nearest Authorized Distributor, contact us at:

SEC HEAT EXCHANGERS
2546 Iona Road, Belfast, PI
Canada, C0A 1A0
Phone: 902.659.2424
Fax: 902.659.2800
Toll Free: 800.335.6650



www.heatexchangers.ca
www.brazedplate.com
www.secplateandframe.com
www.secshellandtube.com
www.secenergy.com
www.indirectwaterheaters.com